



Partito
Partito

Partito – Brings structure to space

Steelcase



steelcase.com

Europe Espace Européen de l'Entreprise . 1, allée d'Oslo . BP 40033 Schiltigheim . 67012 Strasbourg Cedex . France > tel: +33 3 88 13 30 30 > fax: +33 3 88 28 31 78
North America 901, 44th Street . Grand Rapids MI 49508 . USA > tel: +1 616 247 27 10 > fax: +1 616 246 40 40
Asia Pacific & India 4th floor, N32 Kowa Bldg . 2-32 Minami-Azabu . Minato-Ku . Tokyo 106-0047 . Japan > tel: +81 3 3448 9611 > fax: +81 3 3448 9617
Latin America 901, 44th Street . Grand Rapids MI 49508 . USA > tel: +1 616 247 27 10 > fax: +1 616 246 40 40
Middle East & Africa Design House unit A2 . PO Box 502596 Dubai Media City . Dubai . UAE > tel: +971 4 369 7838 > fax: +971 4 369 7837

DM706EN 09/08 © 2008 Steelcase © All rights reserved. All specifications subject to change without notice. ♻️ Printed on at least 80% recycled paper. Printed in France by OTI Imprimeurs - Wasselonne.

C2865

Steelcase

Concept & Design: Bureau De Hoge - www.dfhoge.com Product Design Partito, Kallitro, Moby & Please (as chair): Stefan Brodbeck - www.stefanbrodbeck.com Product Design Partito, Kallitro, Moby & Please (as chair): Oliver Law - C1483



Partito

Since time immemorial, people have had an inbuilt need for their **own personal space**. In today's office environment the situation is no different. That's why Steelcase created Partito, a flexible and ingenious system that **optimises the way in which those valuable square metres are divided up**. Partito brings structure to open areas and offers support for the many different types of tasks carried out during the working day.

Partito – Brings structure to space



Space needs structure

Partito Walls and Screens let you create an effective, open-plan layout with remarkable ease.

With their contemporary design, amazing flexibility and wide variety of connection possibilities, Partito Walls and Screens together optimise valuable square metres and promote harmony between people and their direct environment.

Space needs structure. Partito supplies it.



The Partito system supports the many different types of activities that take place every day in the office.

With one design and two solutions, you can create areas that make it easy for people to work together, or that help them to concentrate and function independently. You can also facilitate communication, create the right ambience for learning,

and even help in the decision-making process. No matter what's going on, Partito can help make it happen. Partito Walls and Screens are simple to integrate into all our desks, so you can build a modern and attractive framework that meets the demands of today's office workers.

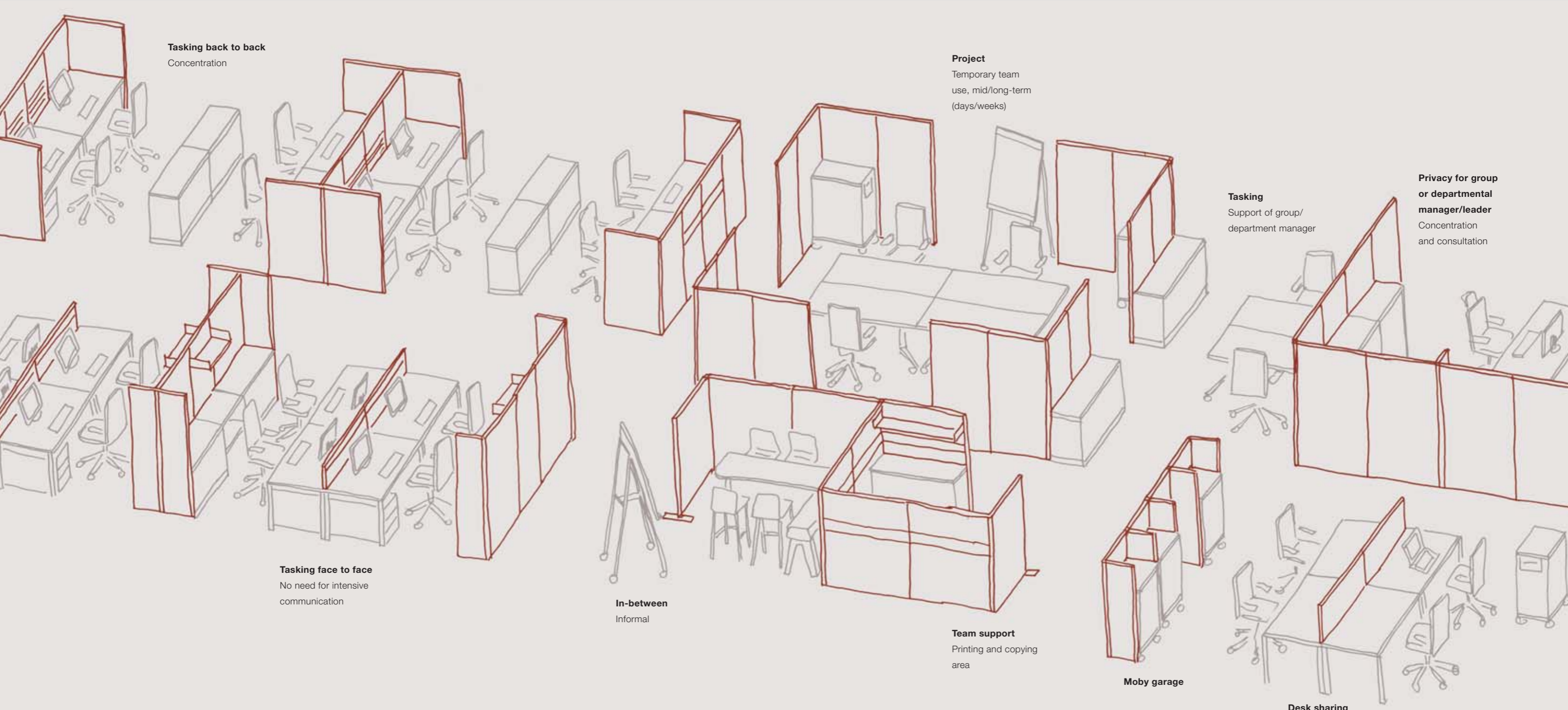

Tasking back to back
Concentration

Project
Temporary team
use, mid/long-term
(days/weeks)

Tasking
Support of group/
department manager

**Privacy for group
or departmental
manager/leader**
Concentration
and consultation

Tasking face to face
No need for intensive
communication

In-between
Informal

Team support
Printing and copying
area

Moby garage

Desk sharing
Temporary (single)
workstations for
short term use
(hours/days)

Wall



Partito Wall – An ingeniously straightforward way of partitioning a room without sacrificing any precious floor space. In addition, clever cable management makes data and power distribution virtually invisible, while acoustic absorption means effective soundproofing.



Your own efficient and economic workspace without the feeling of isolation.



Simple panel Cable tray under desk Cable tray over desk Orga panel 1-rail Orga panel 5-rail Height transition

Screen



Partito Screen – Successfully combining design and functionality. The clear, straight lines combined with the choice of materials and colours help maintain individuality. Adjustable in height for extra convenience, it can incorporate accessories like a flat screen monitor support or other simple tools for efficient organisation of your workspace.



Establish visual, spatial and acoustic privacy while maintaining a sense of openness and freedom.



Height adjustable with Orga panel 5-rail On desk with Orga panel 1-rail and upper panel acrylic double-web

Partito – Balancing communication and concentration

The visual and physical privacy you establish with Partito Walls means you have your own personal space for working independently – or sharing your ideas with others.



B8924

Studies reveal that most innovations occur through working with someone else. Partito gives you the opportunity to do just that.



C1300

On average, 80% of your working time is spent with someone else. Partito is designed to enhance communication by encouraging and facilitating contact with others.



B8874

Everyone has to be able to concentrate. Partito contributes to business performance by giving people the peace and space they need to think clearly and work decisively.



B8924

Partito screens really make a difference when you put several desks together to create a **team bench** in an open-plan environment. As well as providing visual privacy, you enable customisation by different users, who can add or move additional items like pen trays, connectors and monitor supports.

A little **oasis** for yourself, yet still part of the office dynamic.



B8924

Room for everyone

It doesn't really matter how many people there are; the principle is always the same. **With Partito you can simply add on or reconfigure to accommodate extra workstations.**



Just the two of us...

A Partito Screen is all you need to turn one workstation into two.



C0987



C1630



B8829

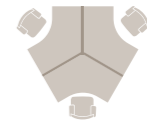

Three's not a crowd...

Simple and structured solutions with plenty of privacy and great visibility. Often seen in call centres.



B8840



For four or more...

Create several islands of partitioned workspaces, while retaining the design freedom to facilitate informal communications, teamworking and many other working practices.

Partito – The backbone of your office

In large, open office environments it's essential to establish structure in the most efficient way possible. Partito allows you to make optimum use of the available space, bringing harmony and balance in a practical and uncomplicated way.

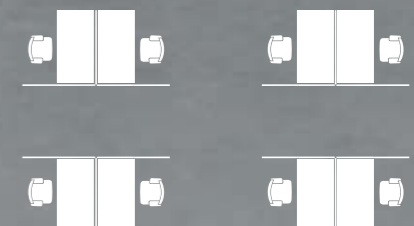

Choosing the best open-plan configuration has never been easier.

A place to call your own

You can only get the best out of people when they feel truly **comfortable and at ease at their workstations.** With Partito you can easily personalise the direct environment so you feel more at home while at work.



B8861

People can spend 30 minutes of each working day searching for information. Partito helps you organise better and find what you need quicker. Add ons like paper trays and binder holders – at whatever height you find most convenient – make many daily tasks go a lot smoother.



C1043



C0983



C0980

Our wide range of **1+1 Worktools** helps you get the best out of the available space.



B8922

It can take up to 15 minutes to fully get back into your work after being disturbed. Noise can be a major source of irritation in the office. Just as well Partito Walls and Screens have excellent acoustic damping properties. You hear less unwanted background sounds, so you can carry on with your work undisturbed. Meanwhile the things you say – think of a confidential phone call – have less chance of being overheard by others.

How Partito manages sound

Partitioning panels containing effective sound-absorbing materials are indispensable in the open-plan offices of today.

Acoustical absorption is the sound power that is not reflected:

- total sound reflection means $\alpha = 0$
- total sound absorption means $\alpha = 1$



Fig. 1 The relevant frequency range for office spaces falls between 250 – 4000Hz.

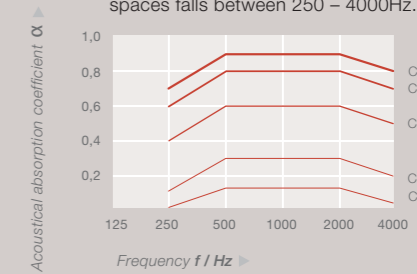

Fig. 2 Partito Wall 35mm qualifies for acoustical absorption Class C. This means 50-90% of the noise occurring will be absorbed between 250 and 4000HZ.

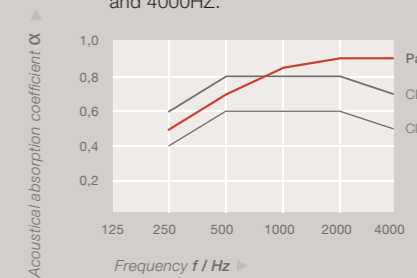
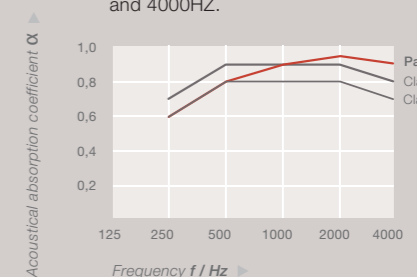

Fig. 3 Partito Wall 50mm qualifies for acoustical absorption Class B. This means 60-95% of the noise occurring will be absorbed between 250 and 4000HZ.



Partito – Organise your space

To get the best out of the available space you need a system that **gives you endless flexibility**, that is adaptable. That offers you plenty of options. Welcome to the world of Partito.



When your workspace is better organised, so are you. With Partito you can plan things just the way you want them, change them around whenever required, and in general make your time at the office more pleasant and productive.



Partito Wall, I-junction 180°



Partito Wall, L-junction 1 x 90°



Partito Wall, X-junction 4 x 90°



Cover cap



Desk connector return screen



Connector stackable screen



Orga panel 1-rail



Orga panel 5-rail



1+1, A4 Letter tray



Shelf



Magnetic board



Flat screen monitor arm



Screen connector return screen



Partito Screen, C-clamp



Partito Screen, desk connector "on desk"



Partito Wall, height transition



Partito Wall, stabilisation foot



Partito Wall, height adjustment screw



Partito Wall, cover profile





By making full use of all the available space – **and running cables in both horizontal and vertical directions** – power and data cables can be neatly routed right up to where they are needed. Without you even seeing them. Get plugged in faster and smarter with Partito.



C0811

Horizontal cable tray, tool free assembly



C0825

Horizontal cable tray, cable guidance



C0829

Horizontal cable tray, cable brackets



C0823

Horizontal cable tray, cover



C2872

Horizontal cable tray, cut out and cover



C0848

Horizontal cable tray, lateral access



C0822

Vertical cable tray, end element

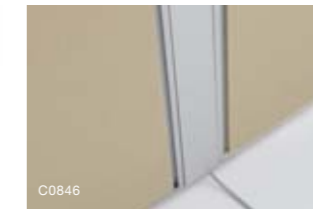

C0846

Vertical cable tray, intermediate element



C0847

Cable guidance vertical/horizontal cable tray



C0818

Vertical cable tray, cover



C0844

Vertical cable tray, cable access on top



C0839

Vertical cable tray, lateral access

Partito Screen – System overview

Height adjustable

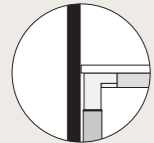
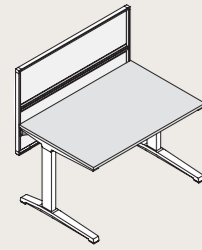

Height adjustable

On top of the desk

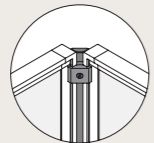
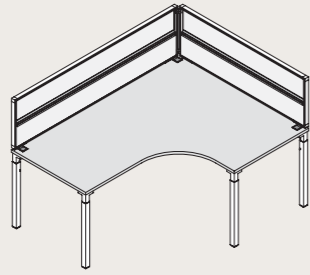

Connector

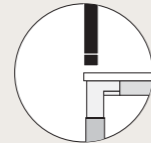

On desk

Back to back

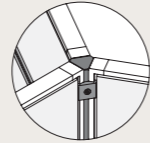
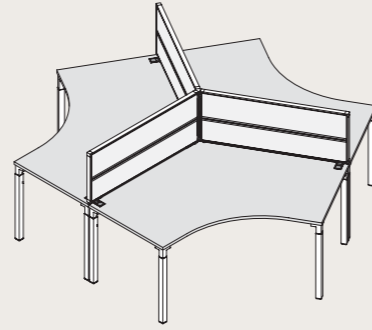

Connector

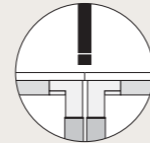

Back to back

Screen 35mm/8mm

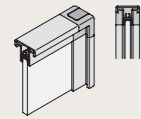

Screen 35mm/35mm

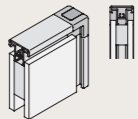

Acoustic screen C-class 35mm/35mm

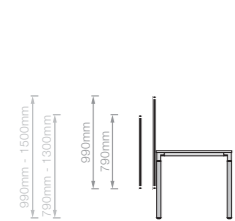
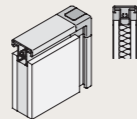

Partito Screen – height adjustable

Simple panel

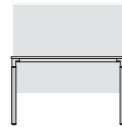

Orga panel, 1-rail (option: acrylic double-web)



Orga panel, 5-rail (option: acrylic double-web)



Orga panel 1-rail

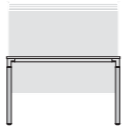

Orga panel 5-rail

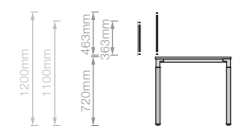

Partito Screen – on desk

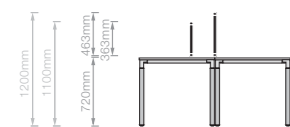

Partito Screen – back to back

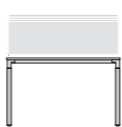
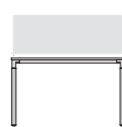

Partito Wall – System overview

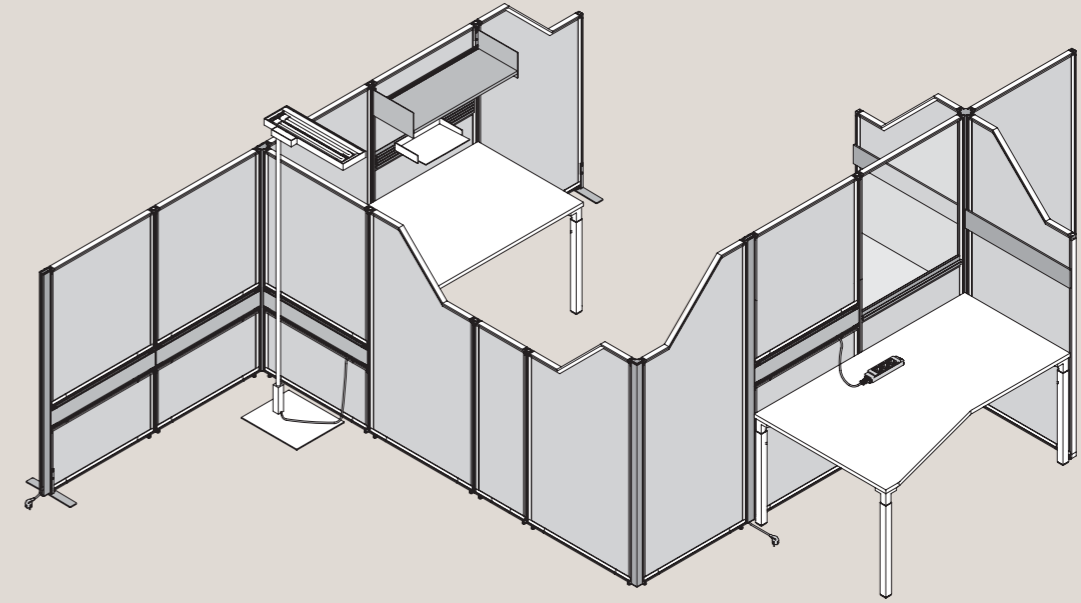

Wall 35mm/8mm

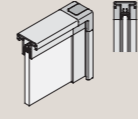

Wall 35mm/35mm

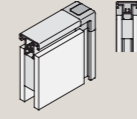

Acoustic Wall C-class 35mm/35mm

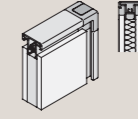

Acoustic Wall B-class 50mm/50mm

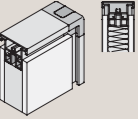

Simple panel

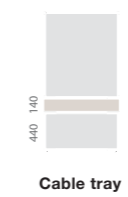

Cable tray under desk

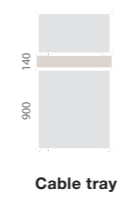

Cable tray above desk

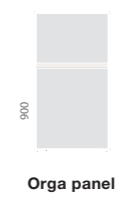

Orga panel 1-rail

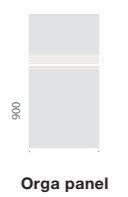

Orga panel 5-rail



Transition

Height

H1100mm	•	•			
H1155mm (3 FH*)	•	•			
H1200mm	•	•			
H1300mm	•	•			1100mm/1300mm
H1400mm (3,5 FH*)	•	•	•	•	
H1487mm (4 FH*)	•	•	•	•	3/4 FH*
H1500mm	•	•	•	•	1300mm/1500mm
H1700mm	•	•	•	•	1500mm/1700mm
H1887mm (5 FH*)	•	•	•	•	4/5 FH*
H1980mm	•	•	•	•	

Width

W400mm	•	•	•	•	
W600mm	•	•	•	•	
W800mm	•	•	•	•	•
W1000mm	•	•	•	•	
W1200mm	•	•	•	•	

* File height

It's your workspace. Why shouldn't it be to your taste? With many different colours and materials to choose from, Partito has everything you need to create something that's contemporary, stylish and pleasing on the eye. As well as on the ear – there's also a choice of infills for different levels of soundproofing.

Two frame thicknesses, several different infill options

50mm Wall

Linked by die-cast zinc corners. A 50mm thick continuous aluminium frame which can be filled with 50mm thick infill that gives class B acoustic damping.

35mm Wall

Infill thickness of 8mm (Melamine, wood veneer, fabric or acrylic double-web) and 35mm (fabric or special fabric with acoustic damping characteristics).

35mm Screen

Infill thickness of 8mm (Melamine, wood veneer, fabric or acrylic double-web) and 35mm (special fabric with acoustic damping characteristics).



Visual privacy / sound absorption



Fabric: Lucia DB21
Top: Melamine Acacia AT



Fabric: Lucia DB22
Top: Melamine Snow WY



Fabric: Gaja 2028
Top: Wood veneer American walnut NU

Wood veneer



Infill: Wood veneer American walnut NU
Top: Wood veneer American walnut NU



Infill: Wood veneer Wenge style WE
Top: Wood veneer Wenge style WE

Acrylic



Infill: Acrylic double-web K50
Top: Melamine Snow WY



Infill: Acrylic double-web K50
Top: Wood veneer Ash choco FJ

Melamine



Infill: Melamine Acacia AT
Top: Melamine Acacia AT





Infill: Melamine Slate 490
Top: Melamine Beech brown B4

Colours not guaranteed – may vary in printing – other colours available

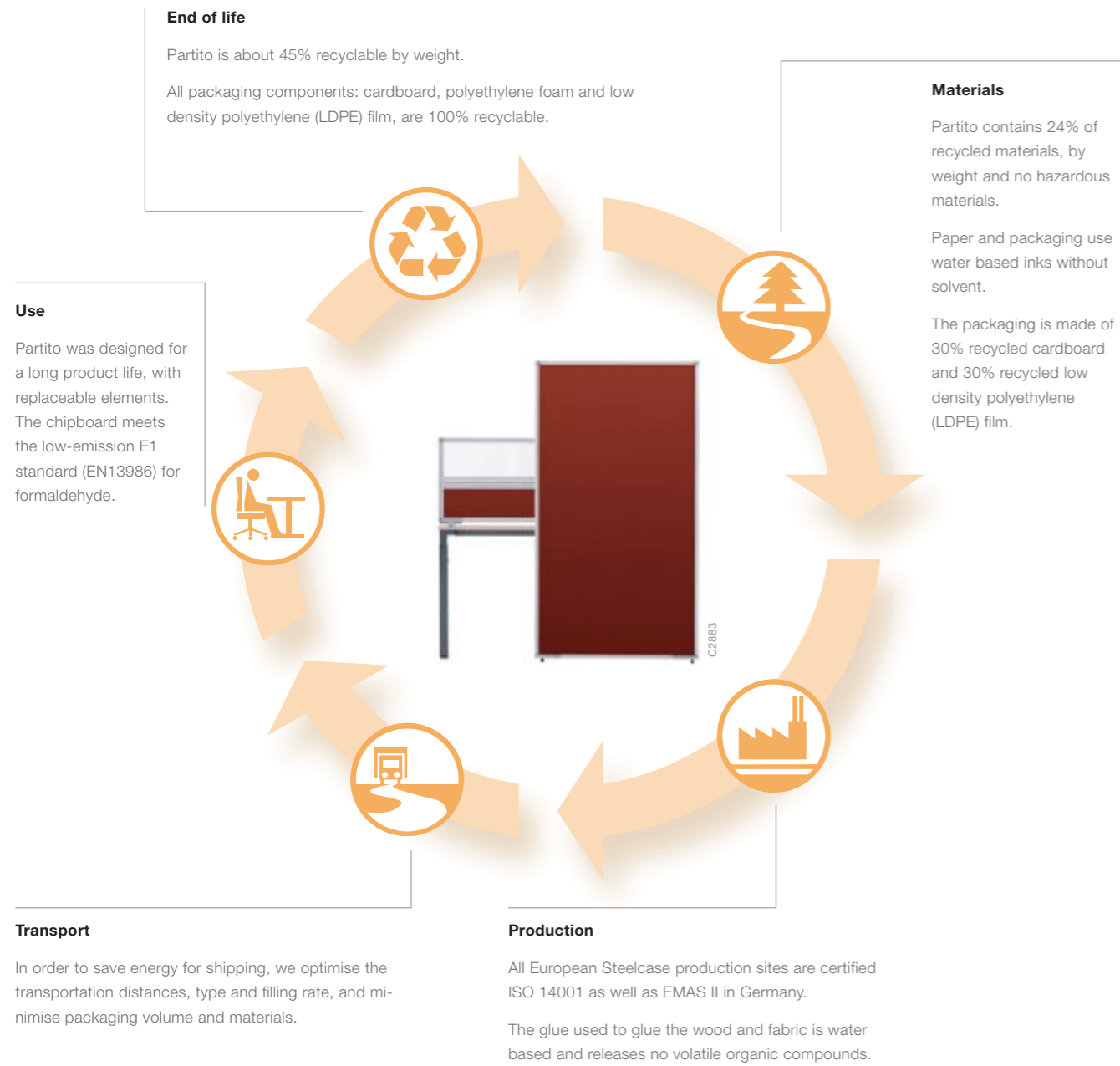
According to our environmental strategy, we carried out a **life cycle assessment** of Partito (based on ISO 14044 standards) to measure the environmental impacts generated at each stage of its life cycle.



With Partito we can provide:

-  The **particle boards** comply with the low emission "E1 standard (EN13986)".
-  The wooden components of Partito are PEFC certified (Programme for the Endorsement of Forest Certification).
-  Environmental Product Declaration: Based on ISO 14025, its purpose is to communicate clear and transparent information about a product's impact on the environment at all stages of its life cycle.

Since 1912, Steelcase has made a meaningful and measurable contribution to the **success of our customers**. We do this using in-depth knowledge of work and work processes as a basis for creating a **better work experience**. We make this possible by offering a wide range of **quality office furnishing solutions** and support that customers can always rely on, no matter where they are in the world. We add **measurable value** by understanding how people work and serving them through our **unmatched global network**. **Sustainability** is embedded in everything we do. This has made us the **preferred partner** for many of the **world's best companies**.