

Love how you work.®

**Steelcase**

Visit [steelcase.com](http://steelcase.com)

**Europe & Africa** Espace Européen de l'Entreprise 1 allée d'Oslo BP 40033 Schilligheim 67012 Strasbourg Cedex France  
tel: +33 3 88 13 30 30 fax: +33 3 88 28 31 78

**North America** 901, 44th Street Grand Rapids MI 49508 USA  
tel: +1 616 247 27 10 fax: +1 616 246 40 40

**Asia Pacific & India** 4th floor, N32 Kowa Bdg 5-2-32 Minami-Azabu Minato-Ku Tokyo 106-0047 Japan  
tel: +81 3 3448 9611 fax: +81 3 3448 9617

**Latin America** 901, 44th Street Grand Rapids MI 49508 USA  
tel: +1 616 247 27 10 fax: +1 616 246 40 40

**Middle East** Design House unit A2 PO Box 502596 Dubai Media City Dubai UAE  
tel: +971 4 369 7838 fax: +971 4 369 7837

**Concept and Design** Steelcase  
**Product design** FlipTop Twin, Mobile Elements, H. System and Qivi Stefan Brodbeck – [www.brodbeckdesign.de](http://www.brodbeckdesign.de)  
**Product design** Think Glen Oliver Löw

DC151EN 11/12 © 2009 Steelcase® All rights reserved. All specifications subject to change without notice.  
Printed on at least 60% recycled paper. Cert no. BV-COC-858659. Printed in France by OTT Imprimeurs – Wasselonne.



**H. System and Mobile Elements**  
The best tools to support collaboration



**Steelcase**

# Observations & Insights

1 - Users want to show, compare and share paper and digital information with ease.

2 - They want to feel comfortable when presenting, installing laptops easily, having access to power and information, food, drink and other stationery.

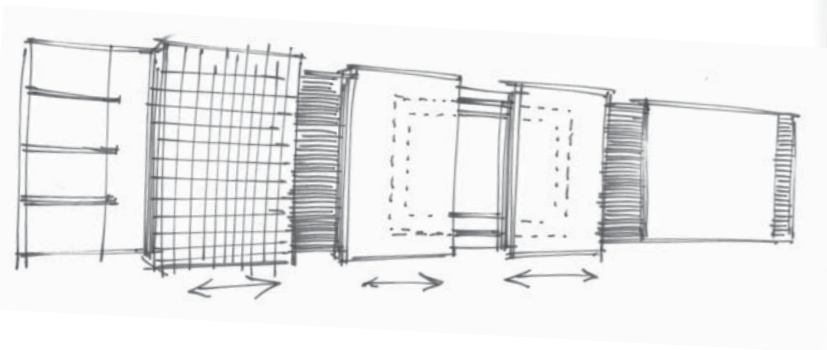

## H. System & Mobile Elements

The best tools to support collaboration

Collaboration is about sharing information and generating new ideas with others – digitally or on paper. Whether you are involved in a formal presentation, a debate or a comparison of data, **the exchange of information needs to be effective and productive.** This requires the right tools.

**Little or no importance is placed on the preparation and organisation of collaborative meetings.** For example, presentation equipment is insufficiently prepared, causing meetings to start late; or inadequate arrangements are made for speakers and presenters, preventing them from adopting comfortable positions or communicating their information easily.

H. System and Mobile Elements have been conceived to make collaboration a success.

### Why H. System?

- 1 - Two-layer system, integrating digital and paper media.
- 2 - Large vertical surface to write on and compare information.
- 3 - Integrated storage elements to store presentation tools.

### Why Mobile Elements?

- 1 - User-friendly solutions for the diverse requirements of collaboration environments.
- 2 - High user-comfort (height adjustable, movable).
- 3 - Intuitive access to power at user level through integrated cable management.





## H. System

The H. System offers large functional space with a wall mounted rail system, to which fixed and movable boards can be attached. **The two-layer system increases the use of vertical surfaces by offering presentation solutions for digital and print media.** Finishes can be co-ordinated with other furniture elements to create a coherent collaboration environment.



### Write

Your notes on the white board or the glass panels can be easily re-arranged to compare information.



### Display

Pin up print information.



### Store

Pencils and other stationery at hand in the integrated storage elements. Panel to hook in 1+1 elements.

### Harmonise

Surfaces can be co-ordinated with other furniture.

### Present

The integrated monitor enables digital media presentation. Cables run behind the panels.

## H. System

The wall mounted rail system is available with different levels of functionality. **The two-layer system allows to upgrade the equipment** from a simple static white and pin board arrangement up to an integrated multimedia system. The modular construction enables simple adjustment and extension as the widths of the panels and units are co-ordinated.

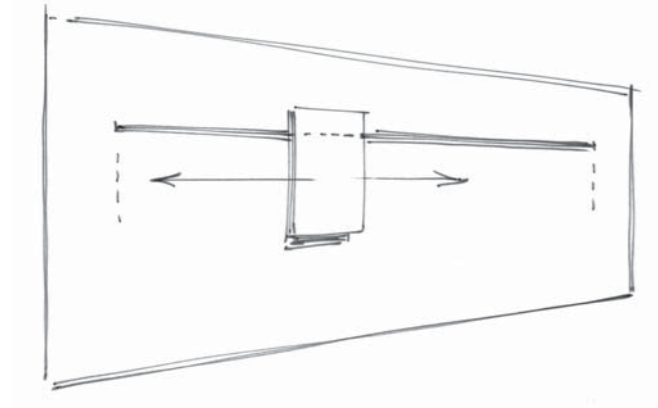

**Movable boards on rail**  
Feel free to position your notes.

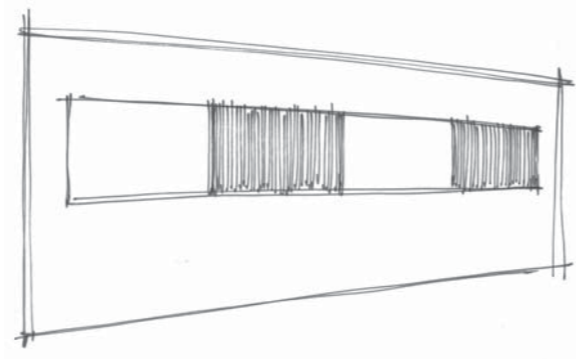

**Static Boards**  
Large fixed presentation space.

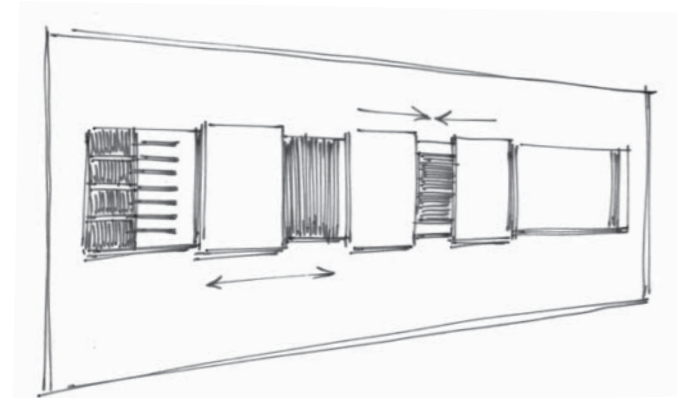

**Combination of static and movable boards**  
The most effective way to re-arrange and compare information.

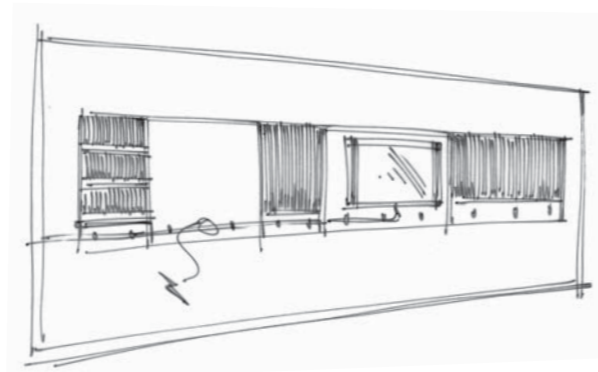

**Integration of monitor**  
Cable management is totally integrated in the system to maintain a clean appearance.



## Mobile Elements

These are intelligently designed supports for the presentation, projection and display of digital and printed information within a collaborative environment.

**Re-arrange and adjust according to your needs.**

Every element with integrated electrification offers access to power at the user level. Colours and surfaces match furniture elements to create a coherent environment.



**Height adjustability**  
for user comfort.

**Integrated electrification**  
Cable run inside the column to the sockets in the drawer of the Cable Box.

**Cable Box**



**Catering**  
Two levels for food and drink.



**Basic**  
Height adjustable.



**Presenter**  
Height adjustable with access to power at user level.



**Media-Mount**  
Integrated monitor on mobile support.



**Lectern**  
Height adjustable with access to power at user level.



**Coat Rail**  
Space for your wardrobe.



**Flip-Chart**  
Adjustable paper hooks and tear-off edge.



**Pin-Board**  
Instant space division and space for presentation.



C4487

## Multifunctionality

The Pin wall makes collaboration easy. By making intensive use of vertical surfaces it helps to show and re-arrange paper or digital information. In addition, **you can create small team spaces instantly by sub-dividing large multipurpose meeting rooms.**

**Space division**  
with the magnetic  
linking of two Pin walls.



C4636

**Projection of  
digital information**  
on the white  
felt surface



C4569

**Easy to roll**



C4634

**Legs with magnetic  
linking**

**Pin information /  
Paper works**

## System overview / H. System

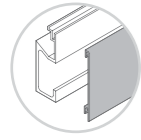



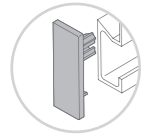



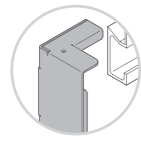

Cover for rail on wall



Small side cover for rail on wall

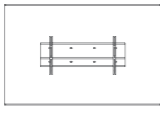

Big side cover for rail on wall

Element	Fixed level (Dimensions in mm)		Movable level (Dimensions in mm)	
	W	H	W	H
	W 740	H 950	W 740	H 1040
	W 1480	H 950	W 1480	H 1040
	W 740	H 950	W 740	H 1040
	W 1480	H 950	W 1480	H 1040
	W 740	H 950	W 740	H 1040
	W 1480	H 950	W 1480	H 1040
	W 370	H 950	–	–
	W 1480	H 950	–	–
	–	–	2 x W 740	H 1040
	W 185	H 950	–	–
	W 370	H 950	–	–
	W 740	H 950	–	–
	W 1480	H 950	–	–

\* Pinnbar, White-Board or Glass

Optional accessories	Fixed level	Movable level
Magnetic pencil holder with 3 pencils	x	x
Magnet-Set (10 pc)	x	x
Cable tray (5 pc)	x	–

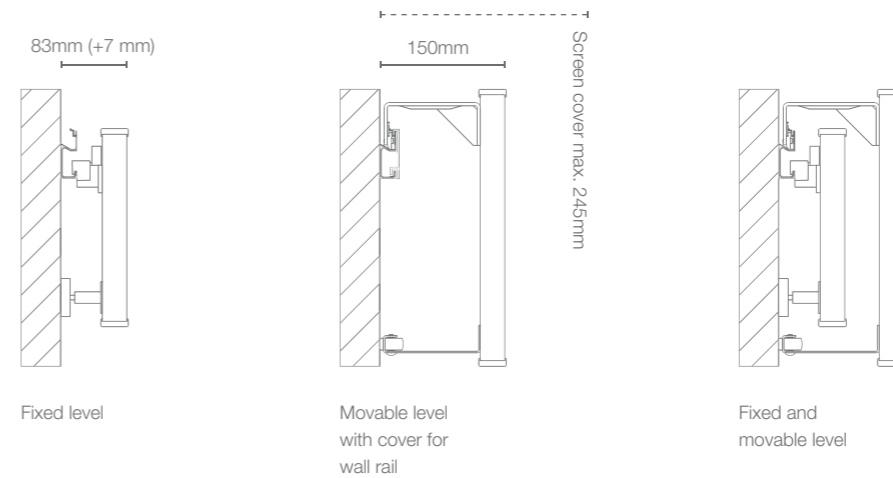

You can order different fixing sets according to wall types (concrete, bricks, plaster or wooden wall).

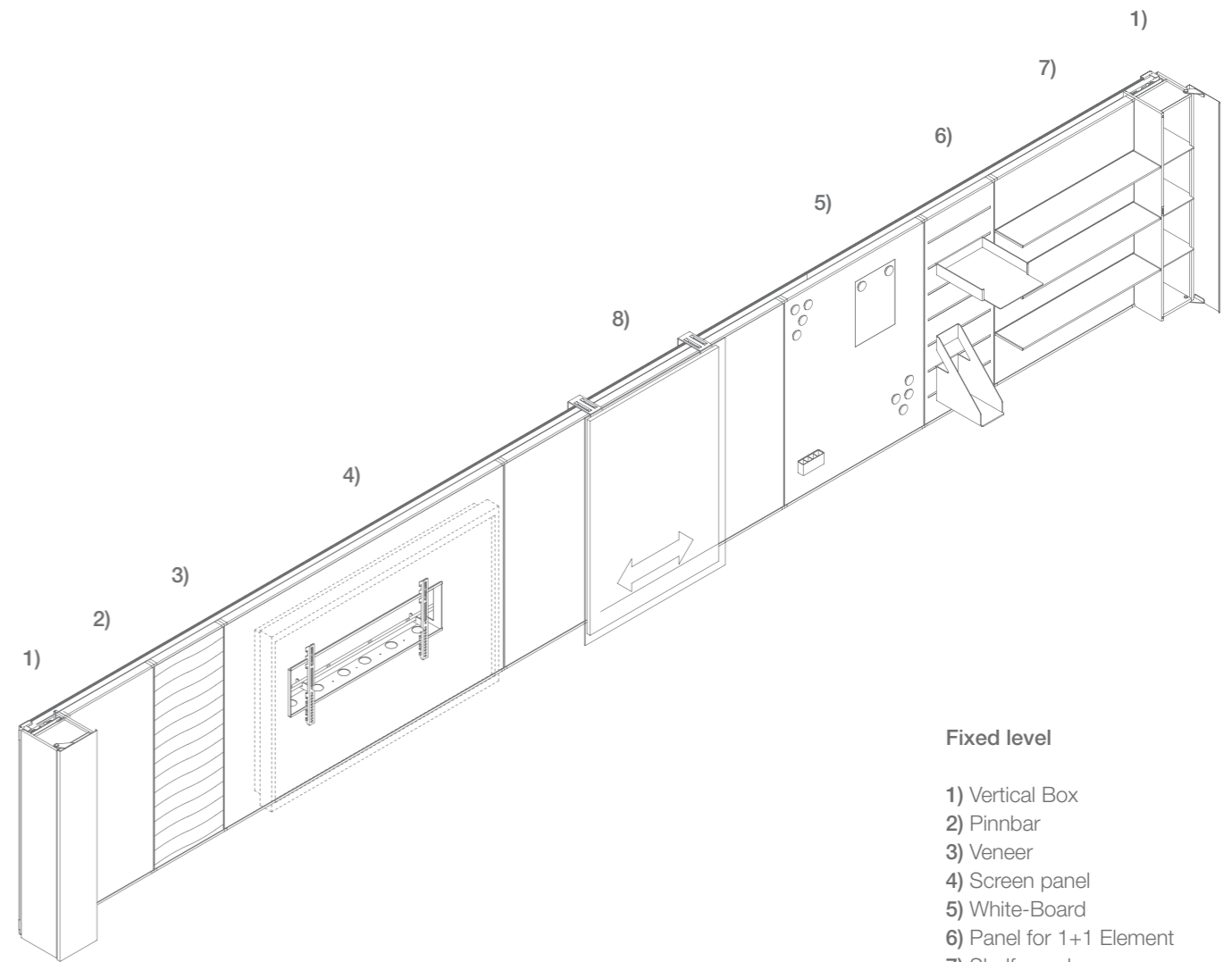

### Fixed level

- 1) Vertical Box
- 2) Pinnbar
- 3) Veneer
- 4) Screen panel
- 5) White-Board
- 6) Panel for 1+1 Element
- 7) Shelf panel

### Movable level

- 8) Glass, white lacquer



## System overview / Mobile Elements

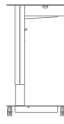

Height adjustability

Elements	Dimensions (in mm)			Electrification	Height adjustability
	W	D	H		
	W 560	D 400	H 740	-	-
	W 560	D 400	H 850-1050	x	x
	W 560	D 400	H 850-1050	x	x
	W 560	D 400	H 850-1050	x	x
	B 740	D 520	H 1643	x	-
	W 560	D 400	H 850-1050	x	x

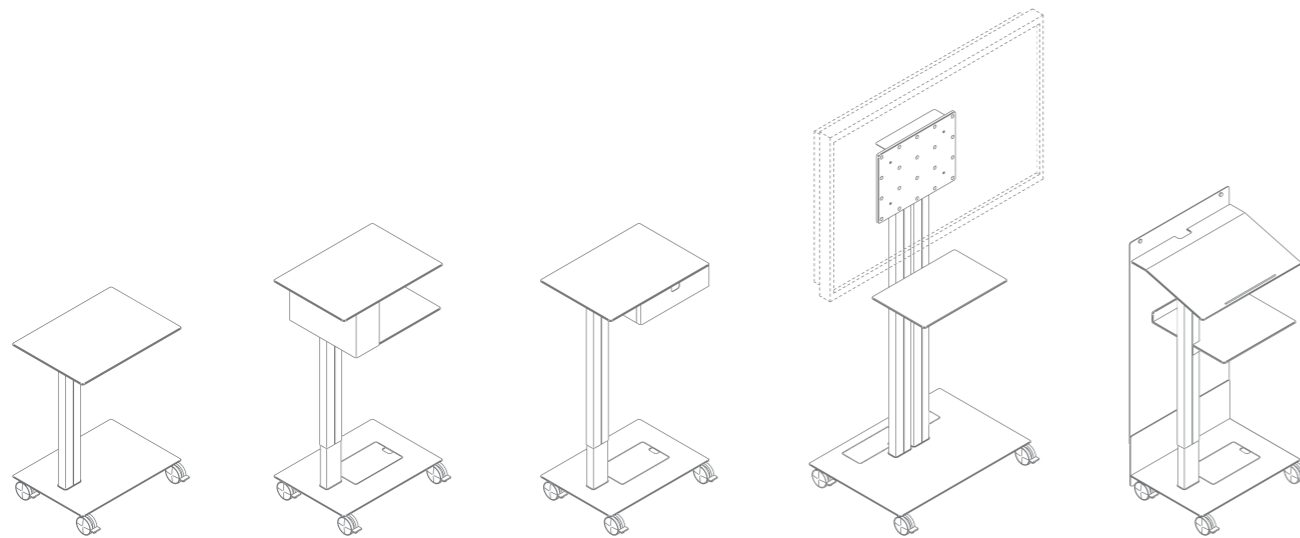





Basic

Presenter

Cable Box

Media-Mount

Lectern

Elements	Dimensions (in mm)			Electrification	Height adjustability
	W	D	H		
	W 566	D 406	H 740	-	-
	W 740	D 450	H 1930	-	-
	W 740	D 450	H 1780-2080	-	x
	W 1280	D 525	H 2000	-	-
	W 560	D 400	H 1800	-	-

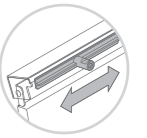

Flip-Chart: Openable edge for paper tear off with variable fixing points

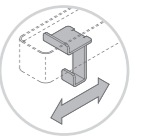

Coat Rail: Including six slidable hooks

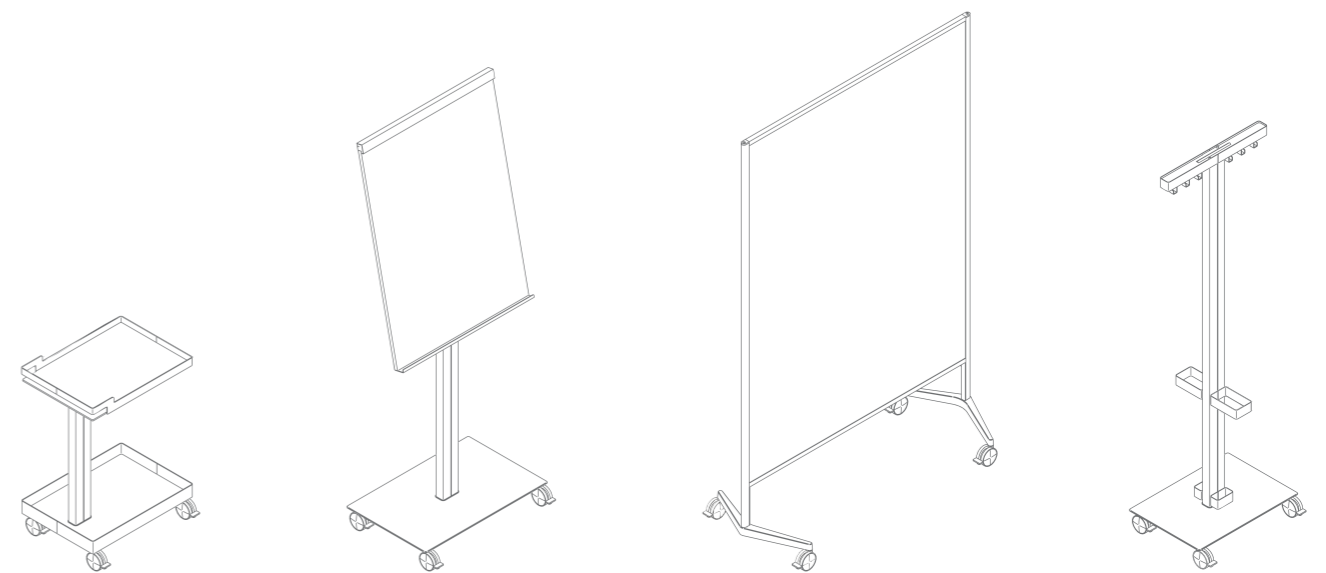

Catering

Flip-Chart

Pin-Board

Coat Rail

## Selection of Finishes

### Melamine

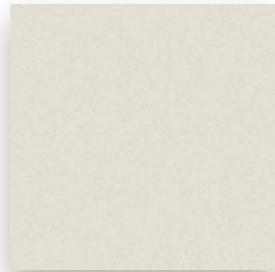

WY Snow

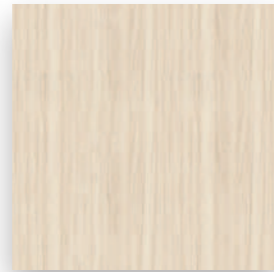

AT Acacia\*



W5 Walnut

### Veneer

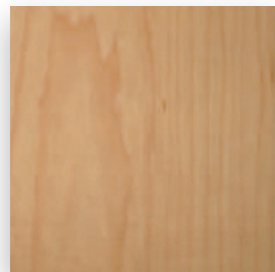

ER Canadian Maple

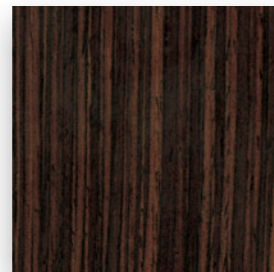

WE Wenge Style

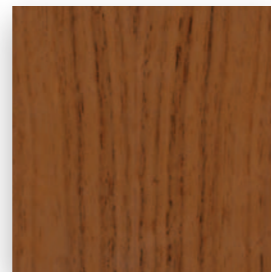

NU American Walnut

### Paint

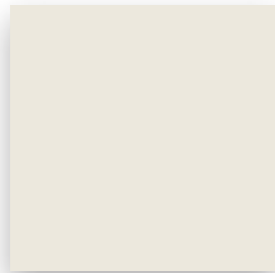

ZX Pearl Snow



ZX Pearl Grey

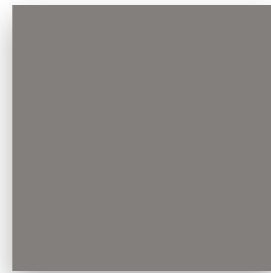

SL Silver

### Fabric

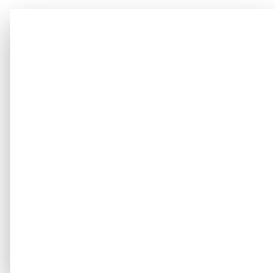

I2 Felt White

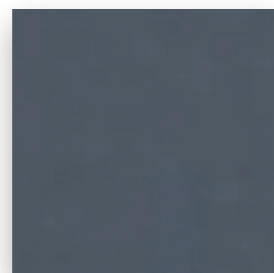

I3 Felt Grey



DB48 Lucia Apple Green

\* Only Mobile Elements

## Mobile Elements environmental performance (example: Presenter)

You need clear evidence to support your environmental credentials. We can provide it.

### End of life

Up to **98%** recyclable by weight.

**100%** recyclable cardboard and LDPE film for packaging.

Plastic parts clearly labelled for easy sorting and effective recycling.

### Material

**42%** recycled content by weight.

**90%** recycled cardboard and **30%** recycled LDPE film (Low Density Polyethylene) in packaging.

### Use

Designed for a long product life.

Replaceable parts.

Maintenance information available on [Steelcase.com](http://Steelcase.com).

### Transport

Manufactured close to customers, in Europe.



### Production

No gluing processes.  
Powder-coat painting:  
VOC-free and free of heavy metals.

You require official certifications. We can deliver them.

### Restriction of the use of hazardous substances in electrical and electronic equipment (RoHS).

RoHS compliant technology components.



**Product Environmental Profile (PEP).** Based on ISO 14021, its purpose is to communicate precise and verifiable information on environmental aspects of the product during its life cycle.

You care about the end of use of your furniture.

We offer options - be it refurbishing, take-back, charitable donation or recycling.

Visit [Steelcase.com](http://Steelcase.com) to discover more about Steelcase's unique ecodesign strategy.